

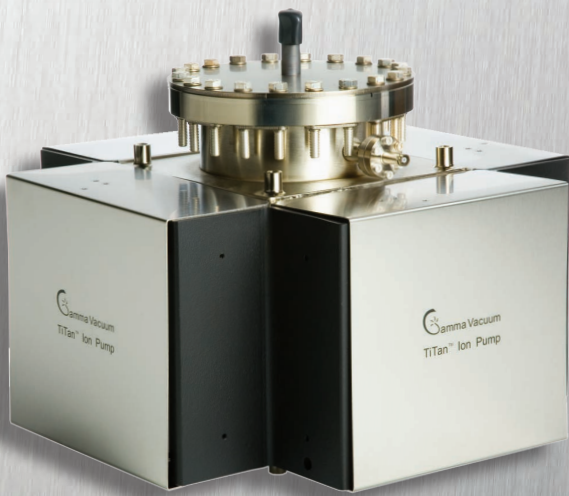

# TiTan™ 400L Ion Pump



## TECHNICAL SPECIFICATIONS

Element Type	CV/CVX	DI/DIX	TR
Pumping Speed (l/s, Nitrogen)	400	320	320
Starting Pressure (mbar)	$\leq 1 \times 10^{-3}$	$\leq 1 \times 10^{-3}$	$\leq 5 \times 10^{-2}$
Lifetime (hours @ $10^{-6}$ mbar)	50,000	50,000	80,000
Ultimate Pressure (mbar)	$< 1 \times 10^{-11}$		
Maximum Baking Temperature (°C)	250 / 450 (without magnets)		
Inlet Flange	DN 150 (8 in.) CFF		
Weight, kg (lbs)	67 (148)		

## DIMENSIONAL DETAILS\*

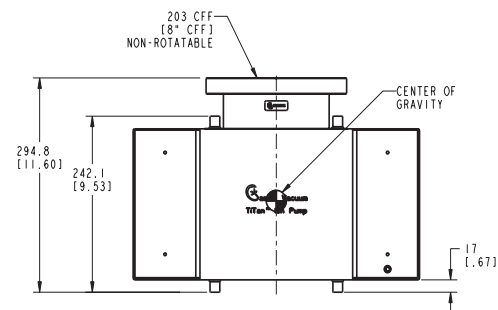
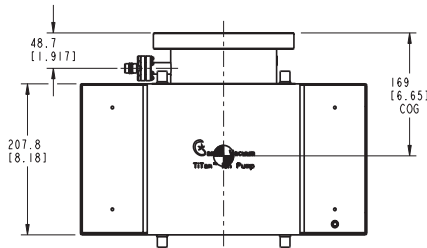
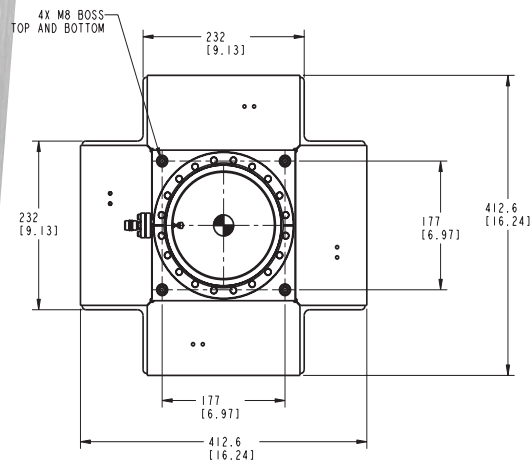

\*Single inlet flange shown. Alternative configurations available at [www.gammavacuum.com](http://www.gammavacuum.com)

**STANDARD OPTIONS\***

Element Styles		Ports		Feedthroughs		Heaters		TSP/NEG	
CV	Conventional 100% Titanium	8S	Single DN 150 (8 in. CFF)	SC	SAFECONN™ 10kV SHV	N	No Heaters	N	Not Installed
CVX	Conventional SEM Shielding	8D	Double DN 150 (8 in. CFF)	OP	Perkin Elmer	110	110-volt 90-130 nominal	TSPA	TSP with Ambient Shield
DI	Differential 50% Titanium 50% Tantalum			OV	Old Varian	220	220-volt 200-240 nominal	TSPC	TSP with Cryo Shroud
DIX	Differential SEM Shielding			VR	StarCell			NEG	SAES® D400-2 or as specified
TR	Triode Slotted Titanium			FI	Fisher				

\*Configured part numbers and pricing are available at [www.gammavacuum.com](http://www.gammavacuum.com). Contact us directly for custom engineered options.

**PERFORMANCE CHARACTERISTICS**

**Pumping Speed vs. Pressure**

measured in accordance with ISO/DIS 3556-1.2-1192

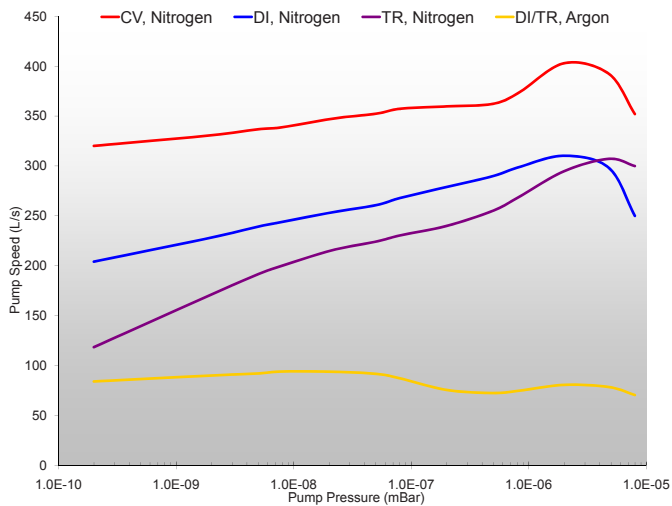

**Current vs. Pressure**

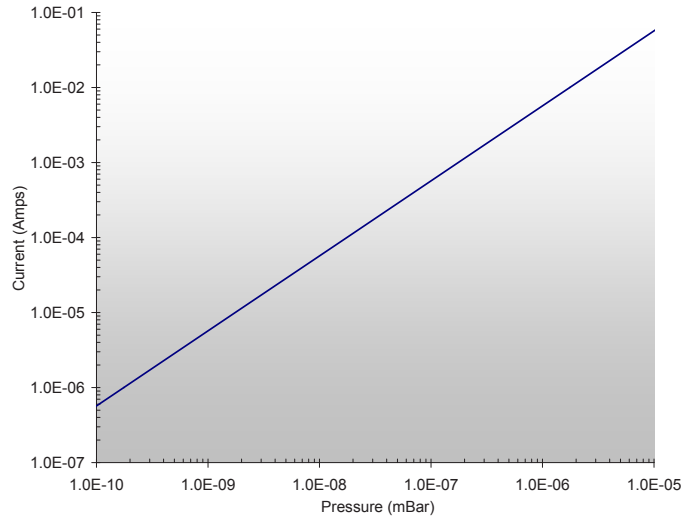

**GAMMA VACUUM**

2915 133rd Street West  
Shakopee, MN 55379 | USA  
800.237.3603 T | 952.445.4841 P  
952.445.7615 F

[gammavacuum.com](http://gammavacuum.com) | [info@gammavacuum.com](mailto:info@gammavacuum.com)